

Ikon Bench

PEDRALI[®]

B863_L - B863_C

100%
MADE IN
ITALY

DESIGN
Pio e Tito Tosso

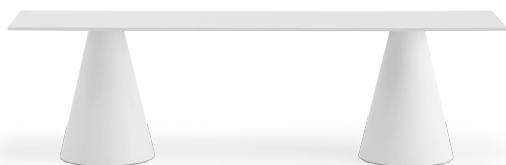

EN: The bench has conical bases in polypropylene glass fibers charged, and a seater in solid laminate

IT: La panca presenta basi coniche in polipropilene stampato a iniezione rinforzato con fibre di vetro e seduta in stratificato

DE: Die Bank hat konische Stützen aus spritzgegossenen, glasfaserverstärkten Polypropylen und eine Sitzfläche aus Multiplex

FR: Le banc a des bases coniques en polypropylène moulé par injection renforcé de fibres de verre et l'assise en stratifié

ES: El banco tiene bases cónicas en polipropileno moldeado por inyección cargado con fibra de vidrio y asiento en laminado compacto

mm - in

• B863_1L

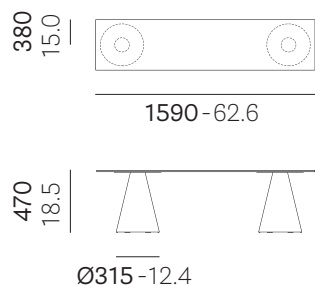

Disassembled
Da assemblare



mc 0,216
ft³ 7.6

SOLID LAMINATE

10mm - 0.39" 12mm - 0.47"



kg 19,4 lb 42.8

kg 21,3 lb 47

• B863_1C

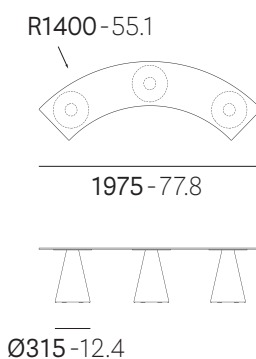

Disassembled
Da assemblare



mc 0,211
ft³ 7.4

SOLID LAMINATE

10mm - 0.39" 12mm - 0.47"



kg 23,7 lb 52.2

kg 25,7 lb 56.6

Examples of IKON bench combinations
Esempi di configurazioni IKON bench

B863_1L

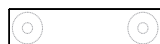

B863_2L

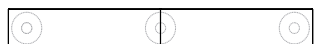

B863_3L

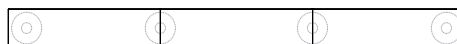

B863_4L



B863_4C

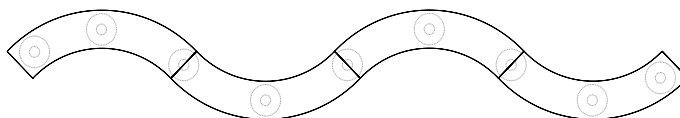

Reproduction of this document is strictly prohibited without prior written authorisation from Pedrali SpA. Sizes, weights and finishes may change without previous notice. È vietata la riproduzione del seguente documento senza previa autorizzazione scritta da parte di Pedrali SpA. Dimensioni, pesi e finiture possono variare senza alcun preavviso.

ST_IKON_BENCH-B863_L-B863-C-2021.0

Ikon Bench

PEDRALI®

B863_L - B863_C

DESIGN
Pio e Tito Toso

B863_1C

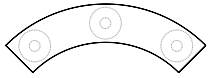

B863_2C

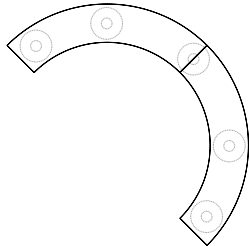

B863_3C

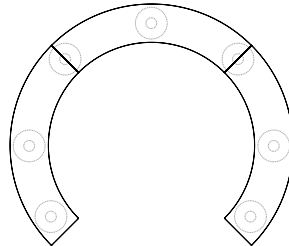

B863_LC

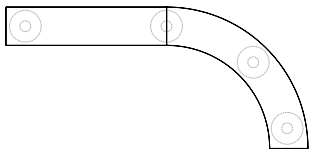

B863_LCC

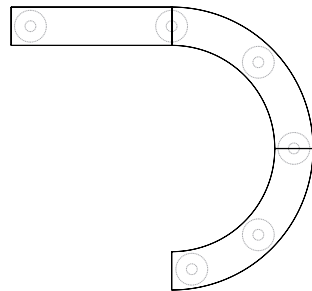

B863_CLC

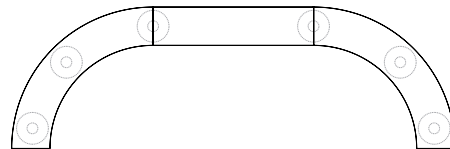

B863_LLC

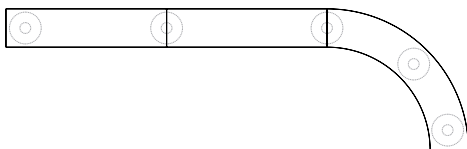

B863_LCL

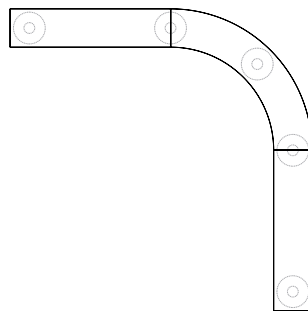

B863_LLLC

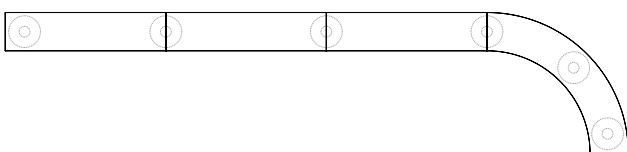

B863_LLCL

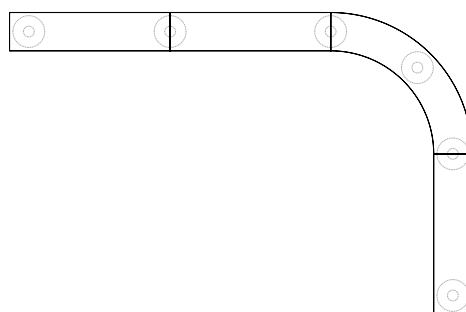

Reproduction of this document is strictly prohibited without prior written authorisation from Pedrali SpA. Sizes, weights and finishes may change without previous notice.
È vietata la riproduzione del seguente documento senza previa autorizzazione scritta da parte di Pedrali SpA. Dimensioni, pesi e finiture possono variare senza alcun preavviso.

ST_IKON_BENCH-B863_L-B863-C-2021.0

Ikon Bench

PEDRALI[®]

B863_L - B863_C

DESIGN
Pio e Tito Toso

B863_CCCL

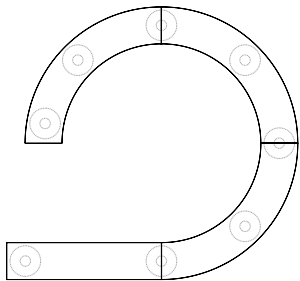

B863_CCLC

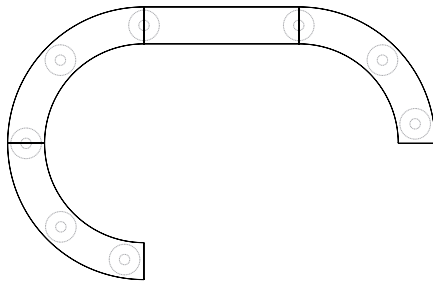

B863_CCLL

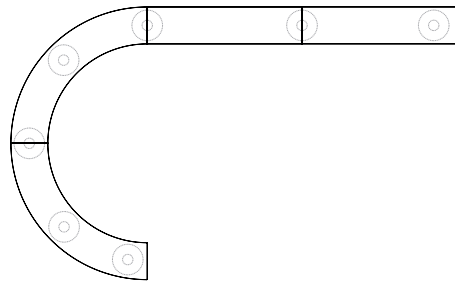

B863_LCCL

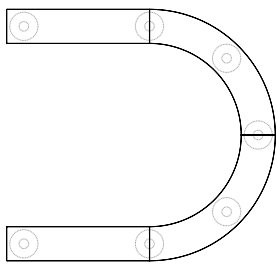

B863_CLLC

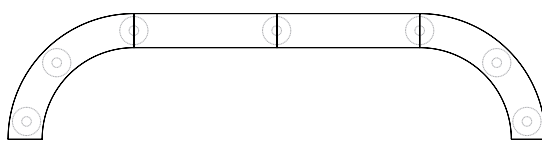

B863_CLCL

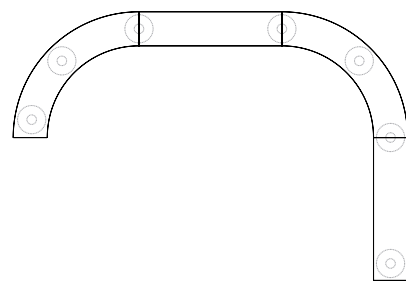

B863C_CLCLCLCL

B863C_CLCCLC

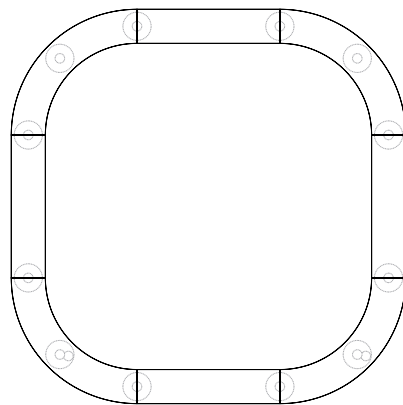
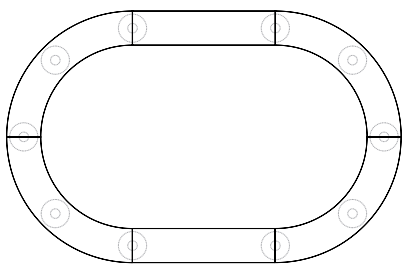

B863C_4C

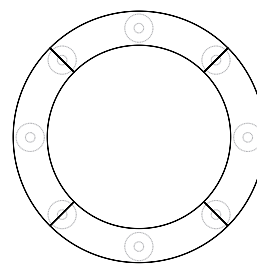

Reproduction of this document is strictly prohibited without prior written authorisation from Pedrali SpA. Sizes, weights and finishes may change without previous notice.
È vietata la riproduzione del seguente documento senza previa autorizzazione scritta da parte di Pedrali SpA. Dimensioni, pesi e finiture possono variare senza alcun preavviso.

ST_IKON_BENCH-B863_L-B863-C-2021.0

MATERIALS

Materiali
Materialien
Matériaux
Materiales

• SEAT - SEDUTA - SITZ - ASSISE - ASIENTO

EN: Solid laminate
IT: Ripiano in stratificato
DE: Kompakt platte
FR: Plateau stratifiés
ES: Sobre compacto

TOP FINISH - FINITURA RIPIANO - AUSFÜHRUNG DER TISCHPLATTE - FINITION PLATEAU - ACABADO SOBRE

SOLID LAMINATE



CFP_BI

TOP / RIPIANO / PLATTE / PLATEAU / SOBRE

10mm thickness / Spessore 10 mm / Stärke 10 mm / Épaisseur 10 mm / Espesor 10 mm

Flat edge / Bordo piatto / Flache Kante / Chant plat / Canto rec

White core / Anima bianca / Weißer Kern / Coeur blanc / Alma blanco



COM_247

TOP / RIPIANO / TISCHPLATTE / PLATEAU / SOBRE

10 mm thickness / Spessore 10 mm / Stärke 10 mm / Épaisseur 10 mm / Espesor 10 mm

Flat edge / Bordo piatto / Flache Kante / Chant plat / Canto rect

Black core / Anima nera / Schwarzer kern / Coeur noir / Alma negra



COM_NE



COM_263

TOP / RIPIANO / TISCHPLATTE / PLATEAU / SOBRE

12 mm thickness / Spessore 12 mm / Stärke 12 mm / Épaisseur 12 mm / Espesor 12 mm

Flat edge / Bordo piatto / Flache Kante / Chant plat / Canto rect

Black core / Anima nera / Schwarzer kern / Coeur noir / Alma negra

• CONICAL BASE - BASE CONICA - KONISCHER FUSS - BASE CONIQUE - BASE CÓNICA

EN: Polypropylene, fiberglass charged, antistatic, UV resistant, hammered surface
IT: Polipropilene, caricato fibra di vetro, antistatico, anti-UV, superficie goffrata
DE: Polypropylen, mit Fiberglas verstärkt, Antistatisch, Anti-UV, Gaufrierte Oberfläche
FR: Polypropylène, renforcé en fibre de verre, antistatique, anti-UV, surface gaufrée
ES: Polipropileno, en fibra de vidrio, antiestático, anti-UV, superficie microtexturada

TECHNOLOGY - TECNOLOGIA - TECHNOLOGIE - TECHNOLOGIE - TECNOLOGÍA

EN: Injection moulding
IT: Stampaggio ad iniezione
DE: Injektionsdruck-Guss
FR: Moulage sous injection
ES: Molde de inyección

COLOURS - COLORI - FARBEN - COLORIS - COLORES

EN: Hammered surface
IT: Superficie goffrata
DE: Gaufrierte Oberfläche
FR: Surface gaufrée
ES: Superficie microtexturada



BI



GC



SA



NE



B863_L - B863_C

DESIGN
Pio e Tito Toso

• **CROSSBAR** - TRAVERSA - TRAVERSE - BARRE TRANSVERSALE - BARRA TRANSVERSAL

EN: Tubular steel 40x30x1.5mm
IT: Tubolare d'acciaio 40x30x1.5mm
DE: Stahlrohr 40x30x1.5mm
FR: Acier tubulaire 40x30x1.5mm
ES: Acero tubular 40x30x1.5mm

EN: Only for version B863_L
IT: Solo per versione B863_L

CROSSBAR FINISH - FINITURA TRAVERSA - CROSSBAR AUSFÜHRUNG - FINITIONS TRAVERSE - ACABADO TRAVERSA

EN: Powder coating
IT: Verniciato con polvere
DE: Pulverbeschichtet
FR: Époxy à poudre
ES: Barnizado con polvo

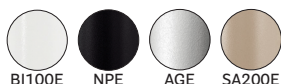

• **FEET** - PIEDINI - GLEITER - PATINS - TACOS

EN: Polyethylene, opaline or black
IT: Polietilene, opalino o nero
DE: Polyethylen, opalin oder schwarz
FR: Polyéthylène, opaline ou noir
ES: Polietileno, opalina o negro

ACCESSORIES

Accessori
Zubehörteile
Accessoires
Accesorios

code B863_FIX

EN: Kit for floor fixing
IT: Kit di fissaggio a terra
DE: Bodenmontage Befestigungskit
FR: Kit de fixation au sol
ES: Kit de fijación al suelo

code B863.4

EN: Cushion
IT: Cuscino
DE: Kissen
FR: Coussin
ES: Cojín

REGULATIONS AND CERTIFICATES

Normative e Certificazioni
Bestimmungen und Zertifikat
Normatives et certifications
Normativas y certificados

• **ENVIRONMENTAL IMPACT** - IMPATTO AMBIENTALE - UMWELTBELASTUNG - IMPACT SUR L'ENVIRONNEMENT - IMPACTO AMBIENTAL

MATERIAL Materiale	Kg WEIGHT Peso	% TOTAL ITEM Totale articolo	MATERIAL RECYCLABILITY Riciclabilità del materiale	% MINIMUM RECYCLED AT ORIGIN Minima riciclato all'origine	% RECYCLABLE END OF PRODUCT LIFE Riciclabile fine vita prodotto
Steel Acciaio	7,15	30,09	YES	33,2	100
Polypropylene Polipropilene	6,6	27,79	YES	0	100
Polyethylene Polietilene	0,003	0,01	YES	0	100
Solid laminate Stratificato	10	42,1	NO	0	0
TOTAL TOTALE	23,75 Kg	--	--	10	57,9%

EN: Percentages referred to IKON Bench B863_1C with solid laminate top, thickness 10mm
IT: Percentuali riferite al IKON Bench B863_1C con ripiano in stratificato, spessore 10mm

• **COMPANY CERTIFICATIONS** - CERTIFICAZIONI AZIENDALI - UNTERNEHMENSZERTIFIZIERUNGEN - CERTIFICATIONS D'ENTREPRISE - CERTIFICACIONES DE LA EMPRESA

ISO 14001
Enviromental management system
Sistema di gestione ambientale



ISO 9001
Quality management system
Sistema di gestione della qualità



Ikon B863.4

PEDRALI
THE ITALIAN ESSENCE

DESIGN
Pio e Tito Toso

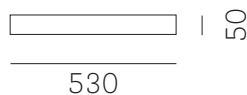
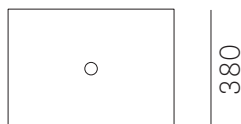
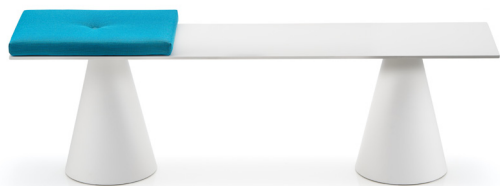

All dimensions are expressed in millimeters.
Tutte le dimensioni sono espresse in millimetri.

Cushion for Ikon bench

Cuscino per Ikon bench / Kissen für Ikon Bank / Coussin pour banc Ikon / Cojín para banco Ikon

MATERIALS

Materiali
Materialien
Matériaux
Materiales

• CUSHION - CUSCINO - KISSEN - COUSSIN - COJÍN

Padded cushion in flexible polyurethane foam fire retardant grade (density 40 kg/m³), underneath side in black Velcro fabric

Cuscino imbottito in poliuretano espanso flessibile ignifugo (densità 40 kg/m³), parte inferiore in tessuto velcrabile nero / Gepolstertes Kissen aus feuerfestem Polyurethan-Weichschaumstoff (Dichte 40 kg/m³), wo das Klettband angebracht werden kann / Coussin rembourré en mousse de polyuréthane flexible ignifuge (densité 40 kg/m³), partie inférieure en Velcro noir / Cojín tapizado de espuma de poliuretano flexible ignífugo, (densidad 40 kg/m³), parte inferior con tela negra para aplicación velcro

FABRIC - TESSUTO - STOFF - TISSU - TEJIDO

Cat. A - C - G - H

• FIXING - FISSAGGIO - BEFESTIGUNG - FIXATION - FIJACIÓN

Fastening with Velcro adhesive tapes applied to the bench

Fissaggio mediante nastri adesivi in Velcro applicati alla panca / Befestigung mit Klettband auf der Bank / Fixation par bandes en velcro appliqués sur le banc / Fijación mediante cintas adhesivas de velcro aplicadas al banco

Reproduction of this document is strictly prohibited without prior written authorisation from Pedrali SpA. Sizes, weights and finishes may change without previous notice.
È vietata la riproduzione del seguente documento senza previa autorizzazione scritta da parte di Pedrali SpA. Dimensioni, pesi e finiture possono variare senza alcun preavviso.